

5143000

FINEZZA UNO Series

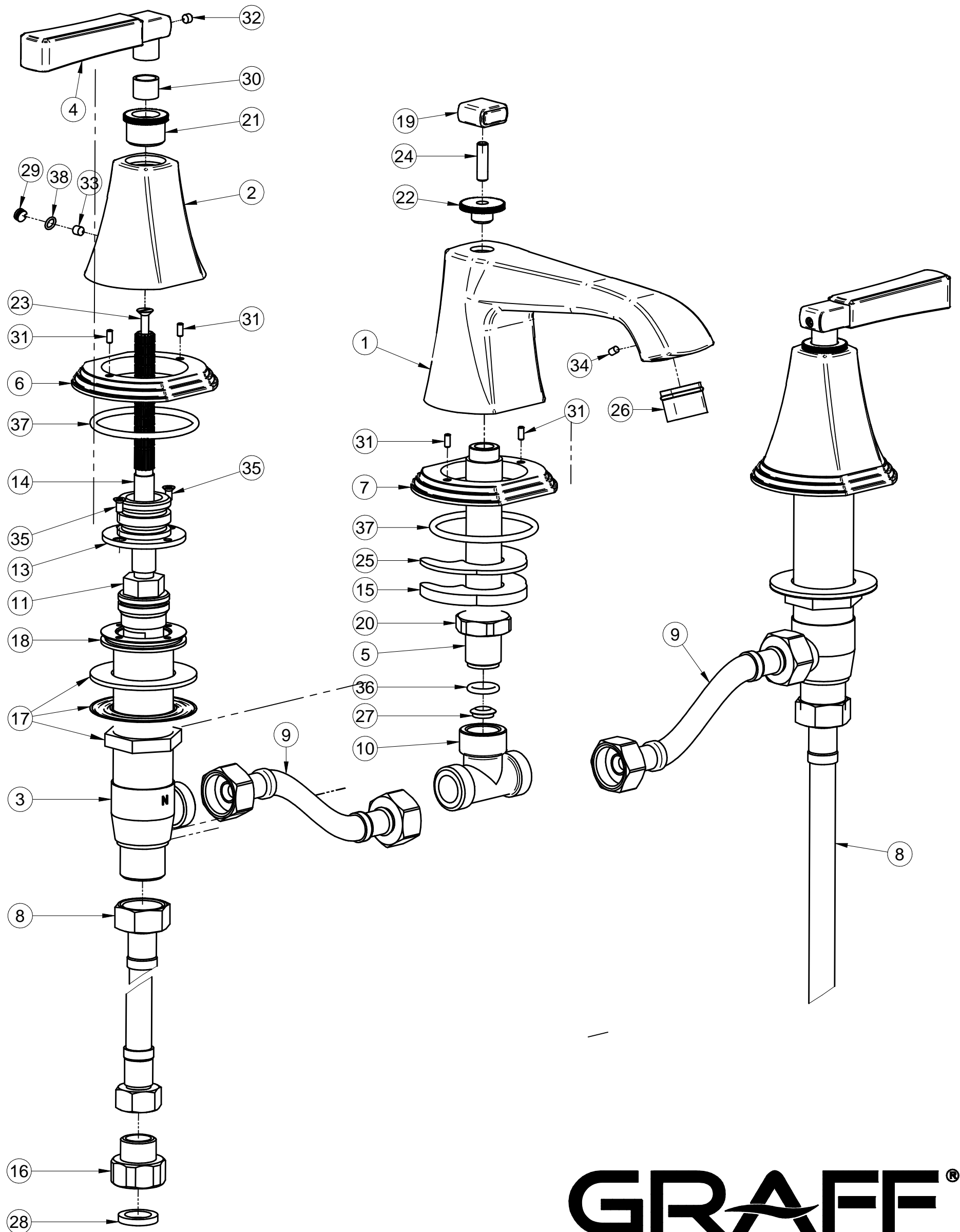

GRAFF[®]
CUTTING EDGE DESIGN