

5155000

Finezza Uno Series

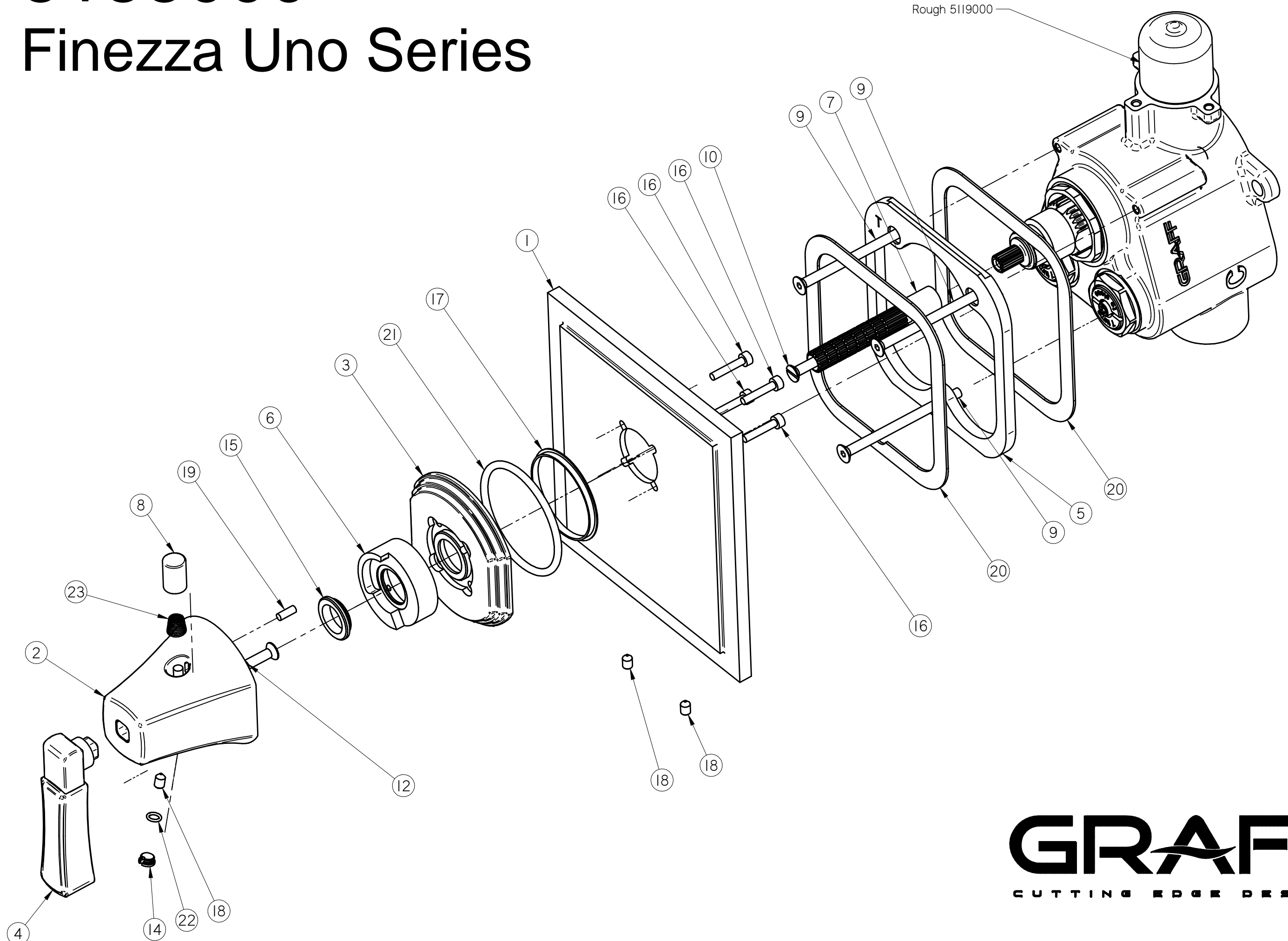

GRAFF[®]
CUTTING EDGE DESIGN