

5167700

FINEZZA DUE Series

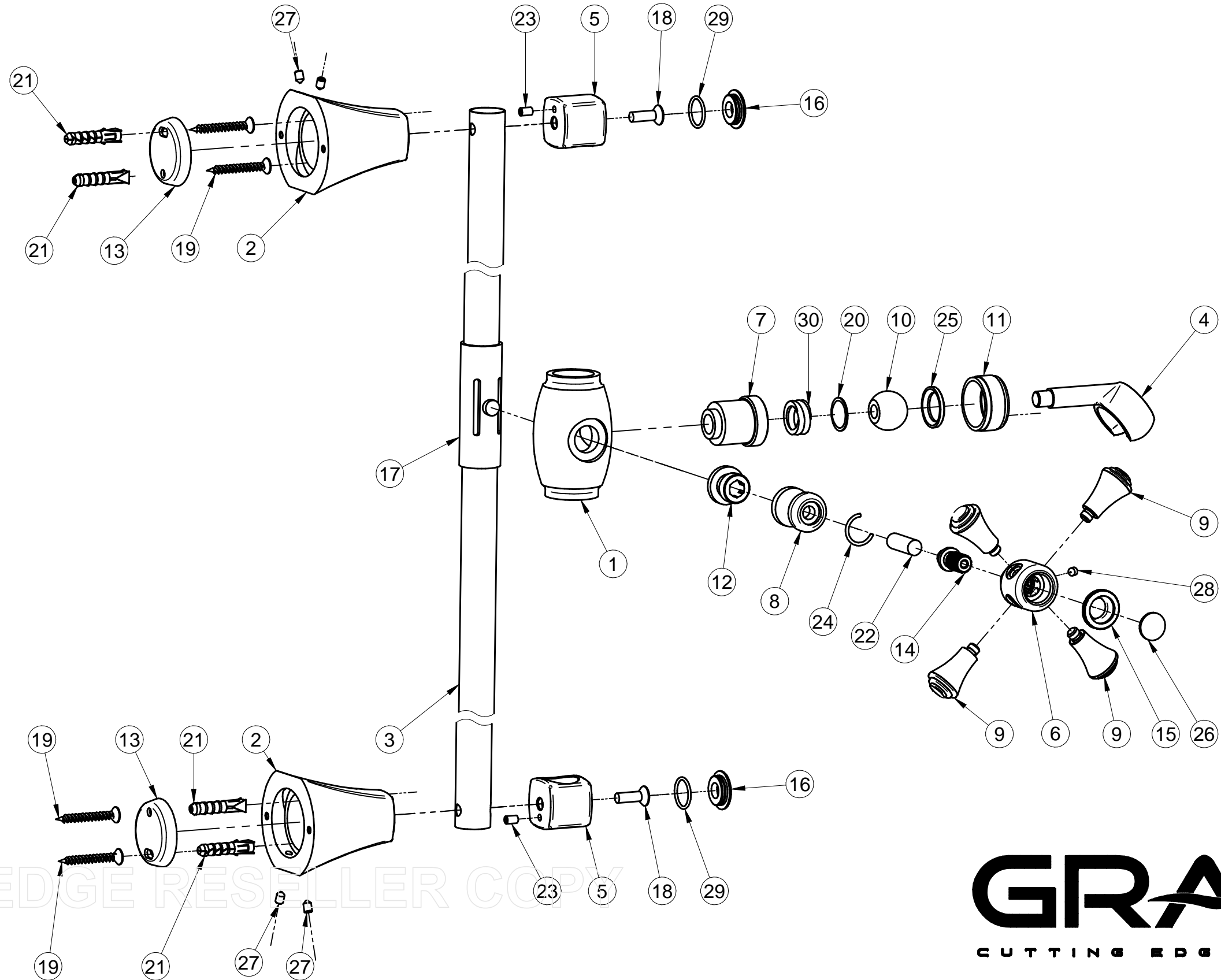

SOLID EDGE RESSELLER COPY