

# E-6144-LM41M-T

## ME Series

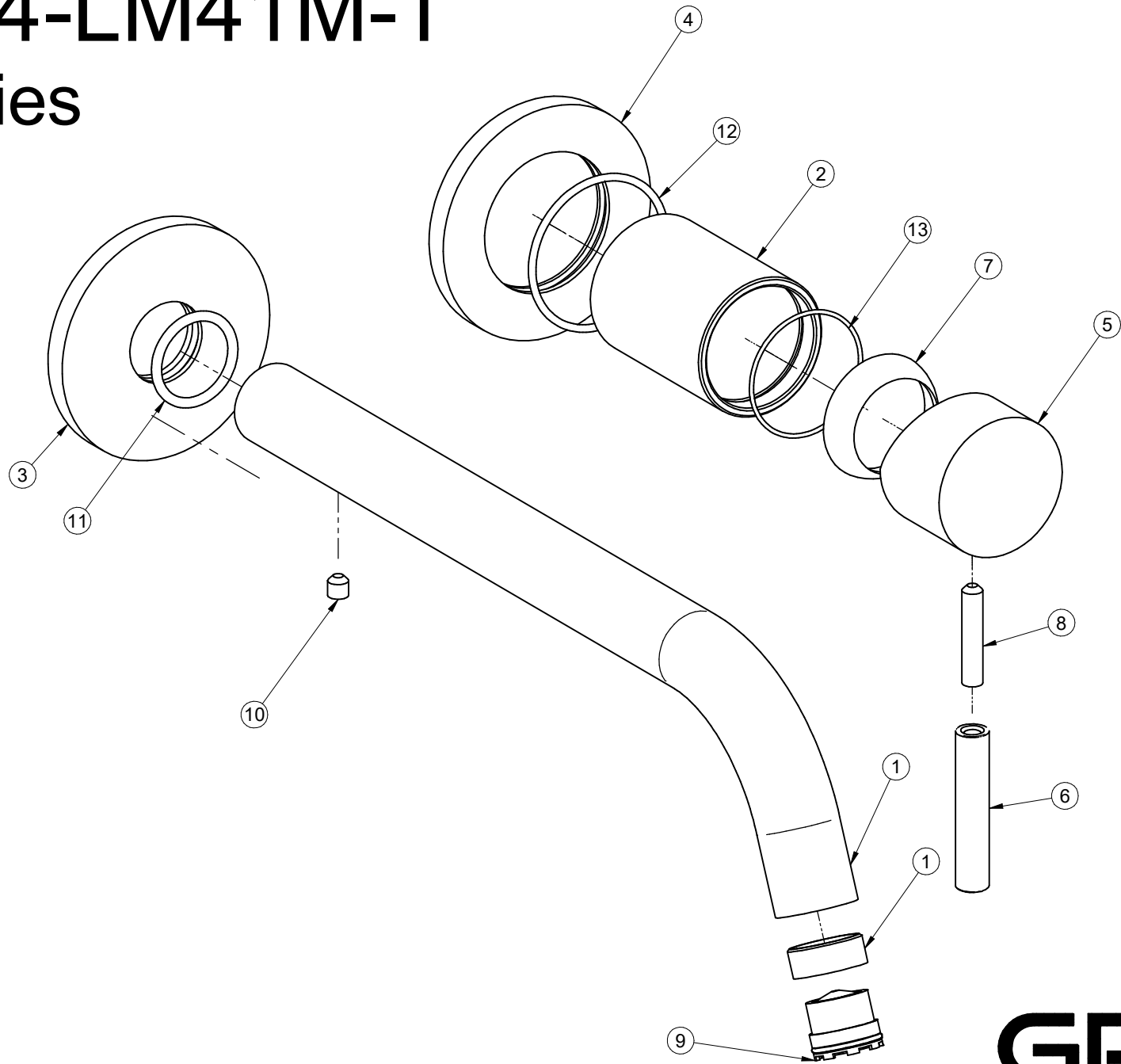

**GRAFF**<sup>®</sup>  
Art of Bath