

5163600

FINEZZA UNO Series

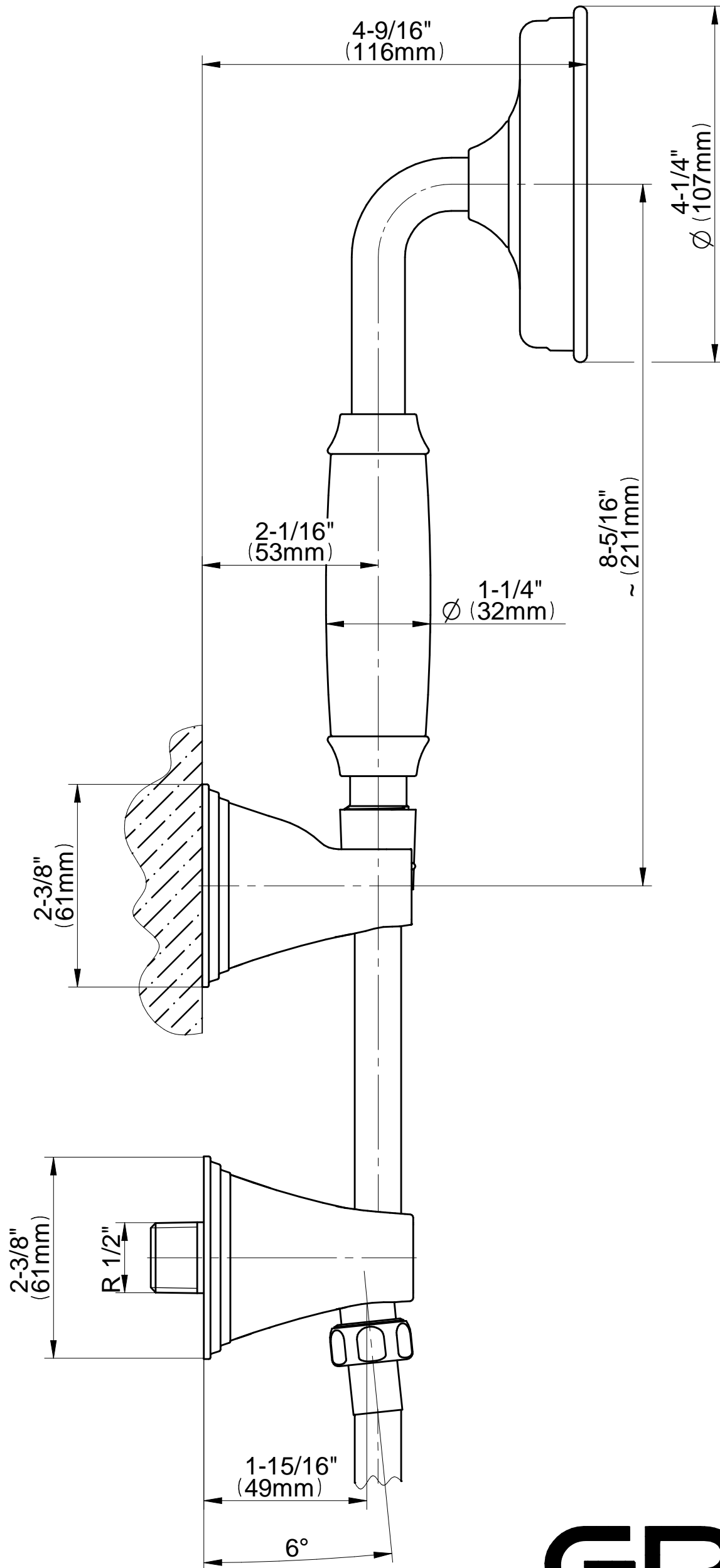

GRAFF[®]
CUTTING EDGE DESIGN