

# E-18035-LM45E-\*\*-T

## Uni-Box Series

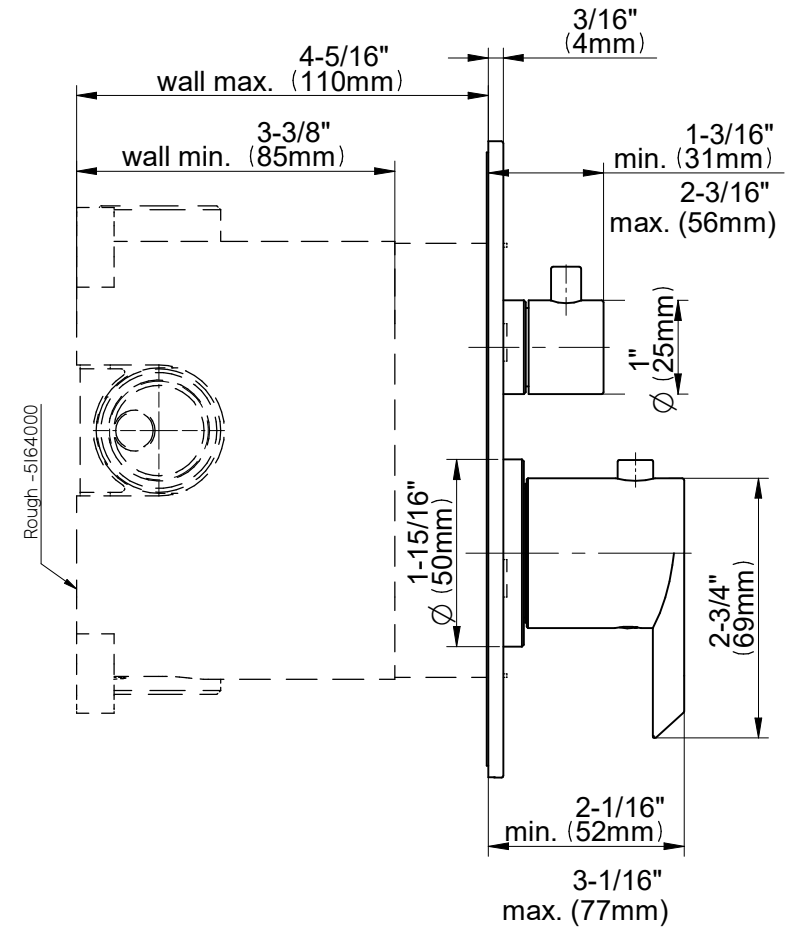
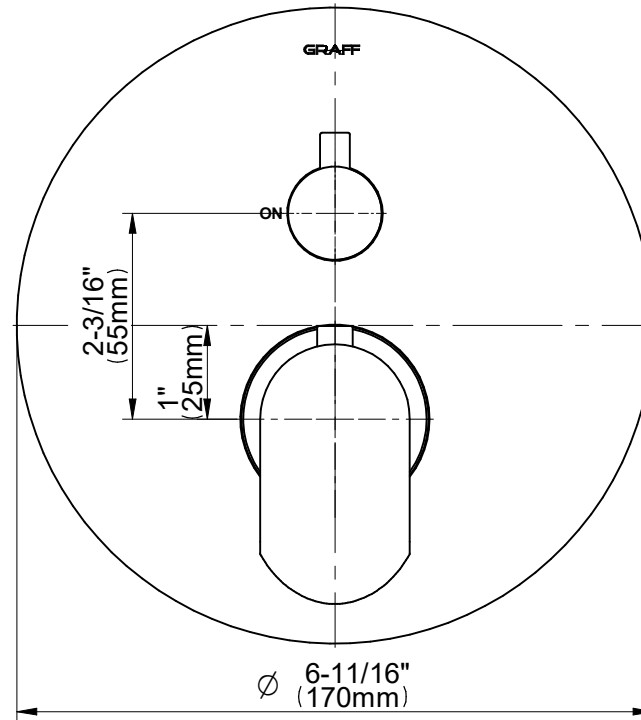
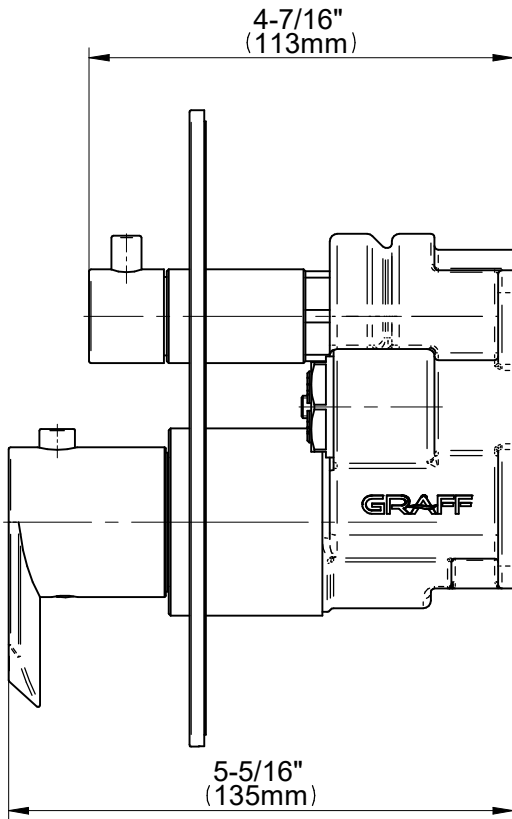

**GRAFF®**  
Art of Bath